

Implementation of a viscoelastic material model to predict the compaction behavior of dry carbon fiber preforms

Dennis Bublitz, M.Sc.

Mario Angstl, B.Sc.

Dr.-Ing. Mathias Hartmann

Prof. Dr.-Ing. Klaus Drechsler

03.06.2019



Agenda

- 1 Motivation**
- 2 Material Modelling**
- 3 Implementation in ANSYS**
- 4 User defined material model**
- 5 Conclusions and Outlook**

1. Motivation

Compaction effects in RTM tools for complex parts

- Wrinkles in T-section
- Corner thinning, thickening
- Over compacted areas
- Gaps and overlaps of preforms

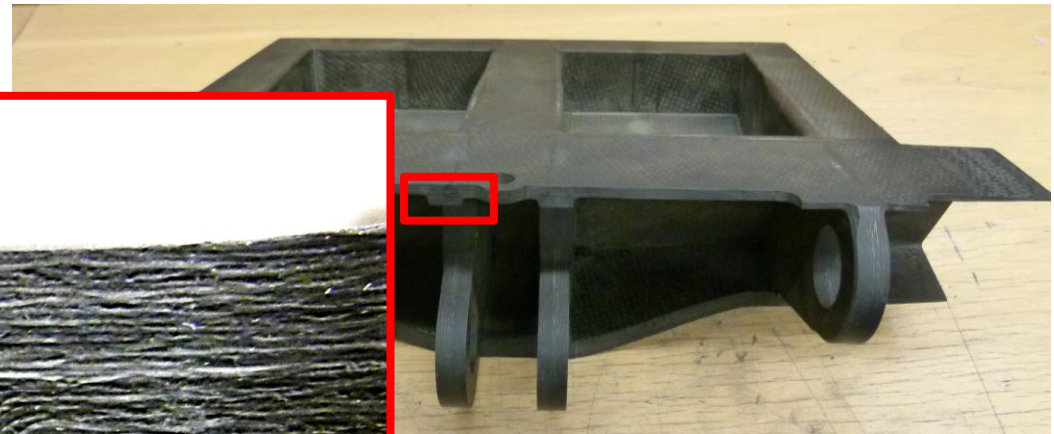
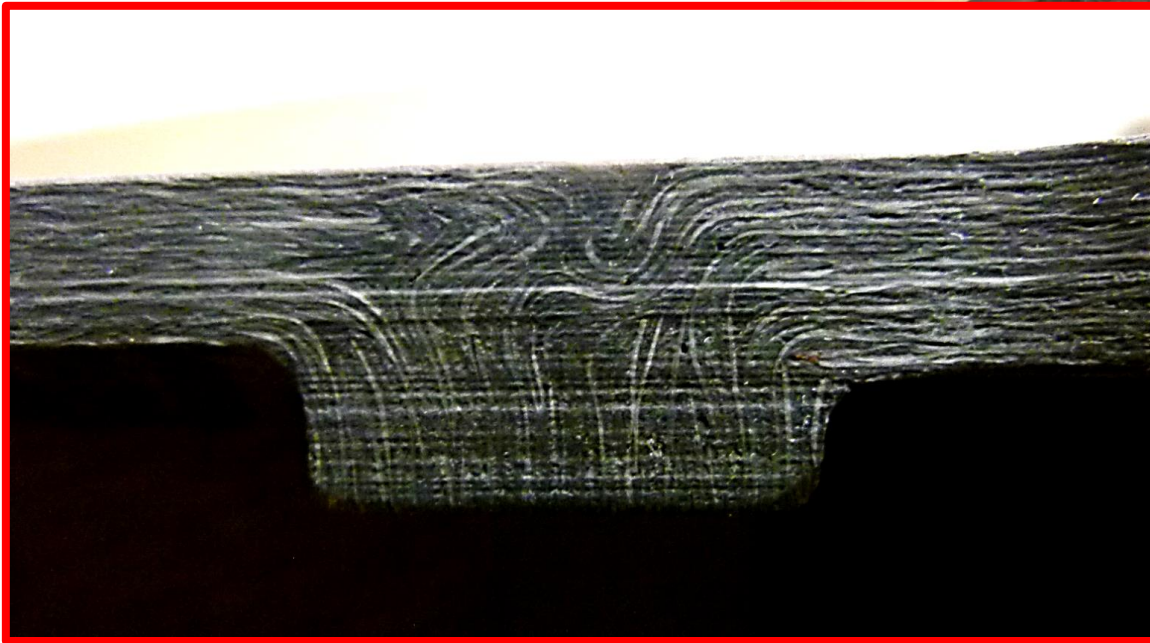

Composite part built with RTM

1. Motivation

What causes these effects?

- Closing of RTM tool
- Thermal expansion of tool
- Thermal expansion of inserts
- Movement of floating inserts

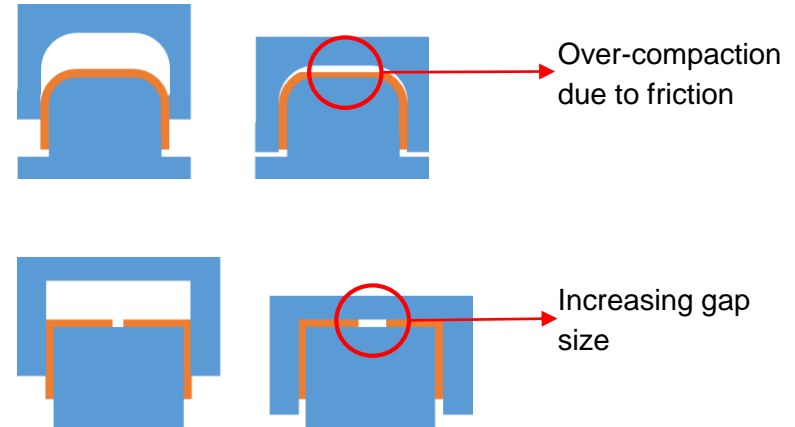

How do these effects influence the final part quality?

- Gaps and over-compacted areas act as additional flow channels
- Fiber volume fraction (FVF) gradients as main driver of distortion effects
- Influence on mechanical properties

1. Motivation

Viscoelastic behavior of preforms

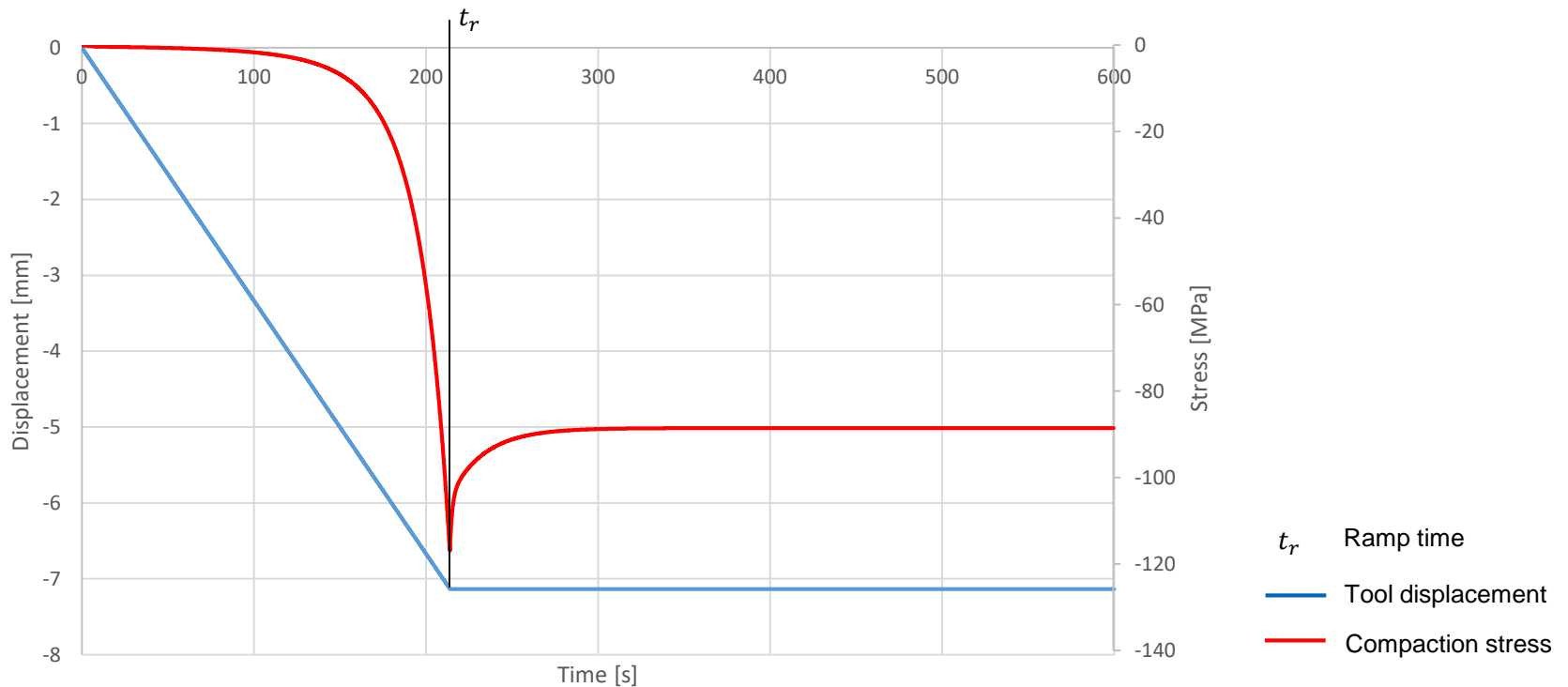

Compaction pressure progression during RTM processing

2. Material Modelling

Literature review – Viscoelastic material modelling

- Compaction and relaxation modelled separately: Kim 1991 [1]
- Compaction and relaxation of glass fiber preforms: Kelly 2004 [2]
- Phenomenological models for glass fiber preforms: Kelly 2011 [3]
- Relaxation model for glass fiber preforms: Someshkar 2012 [4]
- Generalized Maxwell model for woven carbon fibers: Danzi 2018 [5]

Evaluation

- Model from Danzi et al. is most suitable
 - Compaction and relaxation can be described in one equation
 - Results could be reproduced analytically

→ Implementation in ANSYS

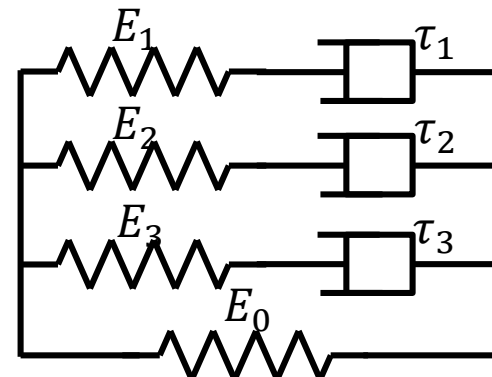

2. Material Modelling

Preliminary work - Material modelling

- Stress as a function of strain and strain rate [2]

$$\sigma(t) = \dot{\epsilon} \left\{ \begin{array}{l} E_0 t + \tau_1 E_1 \left(1 - e^{-\frac{t}{\tau_1}}\right) + \tau_2 E_2 \left(1 - e^{-\frac{t}{\tau_2}}\right) + \tau_3 E_3 \left(1 - e^{-\frac{t}{\tau_3}}\right) \\ + \Theta(t - t_r) \left[E_0(t_r - t) + \tau_1 E_1 \left(e^{\frac{t_r - t}{\tau_1}} - 1\right) + \tau_2 E_2 \left(e^{\frac{t_r - t}{\tau_2}} - 1\right) + \tau_3 E_3 \left(e^{\frac{t_r - t}{\tau_3}} - 1\right) \right] \end{array} \right\}$$

- Relaxation is activated by a heaviside function
- Only applicable for constant strain rate
- Compaction behavior is defined by 17 constants
 - 2 constants / spring $E_i = a \cdot e^{\epsilon_{rel} \cdot b}$
 - 3 constants / dashpot $\tau_i = m \cdot \dot{\epsilon}^n + o$

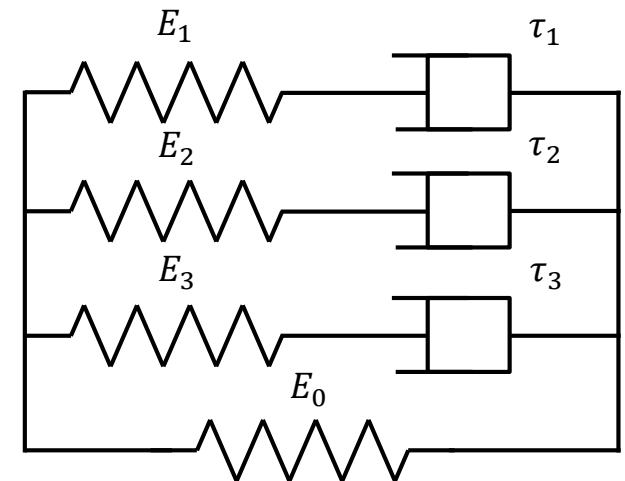

Generalized Maxwell model

3. Implementation in ANSYS

Implementation of material model

- ANSYS offers a viscoelastic material model with linear elastic springs
- Combination with hyper-elastic material model

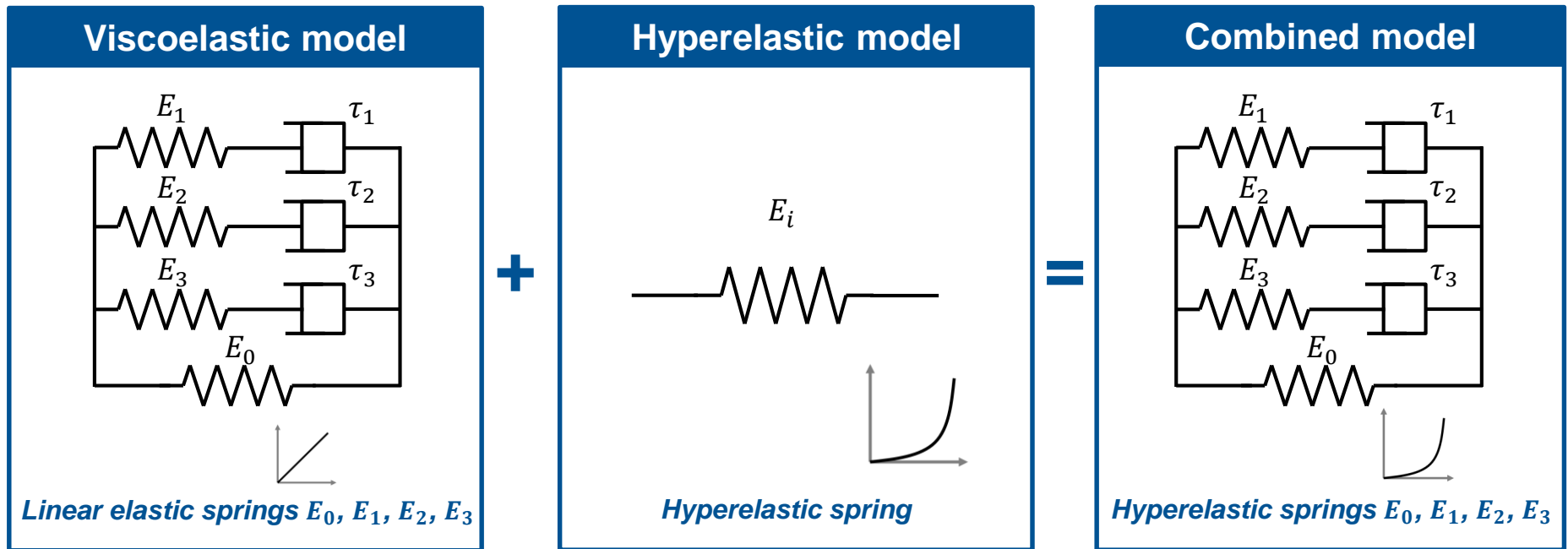

3. Implementation in ANSYS

Implementation of material model

- Combined model did not show good results
 - In ANSYS relaxation starts at $t = 0$
 - Literature model takes relaxation into account only after ramp time

Workaround: Two independent meshes

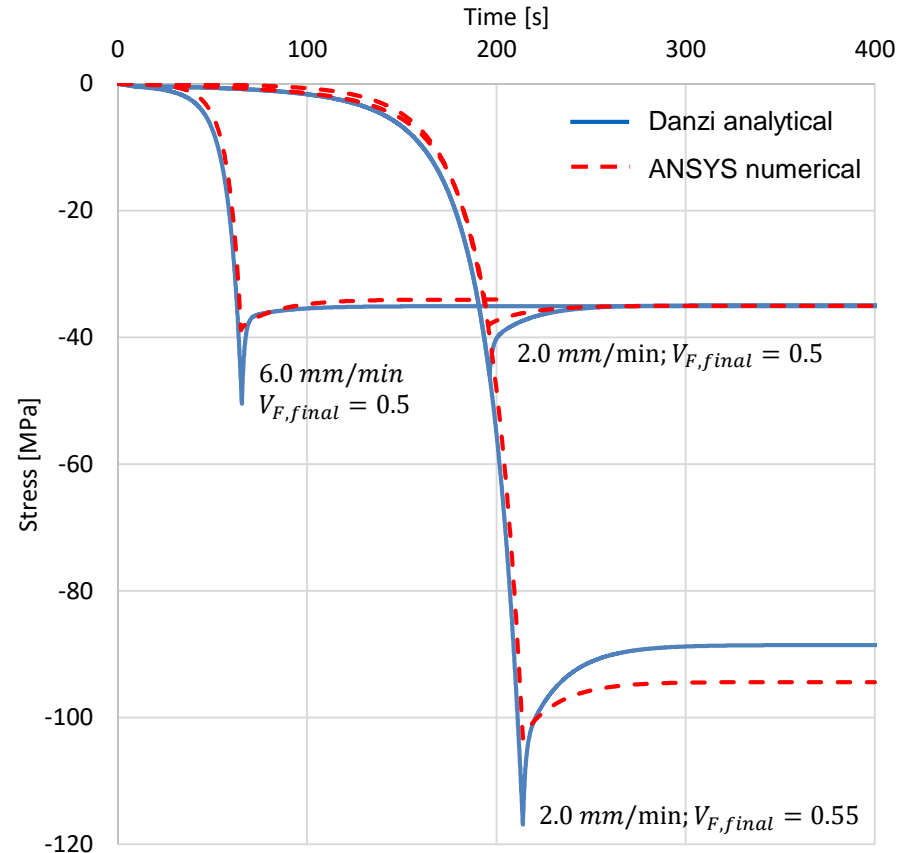
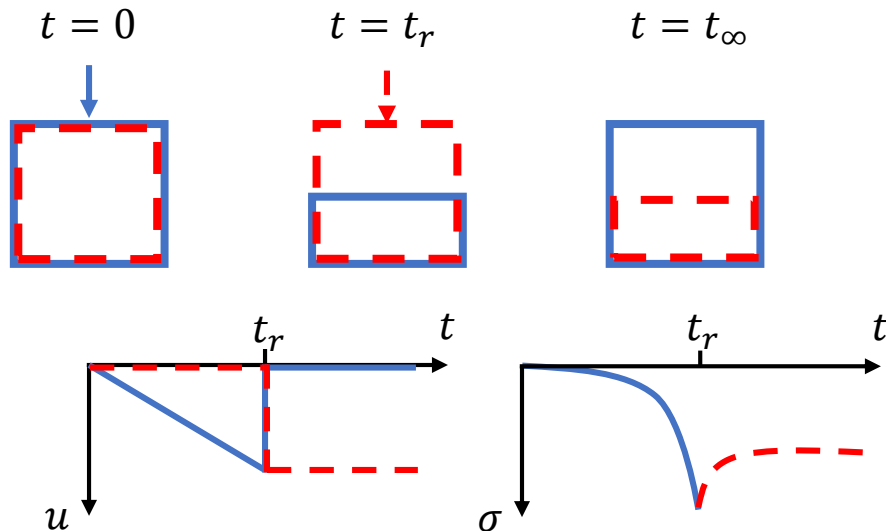

Comparison of numerical results (ANSYS) with experimental data from literature [2]

3. Implementation in ANSYS

Implementation of material model

- Good results
- Using the workaround

Drawbacks

- High modelling effort
- Difficult for complex geometries
- Only isotropic behavior

Solution

- Writing a user defined material model in ANSYS

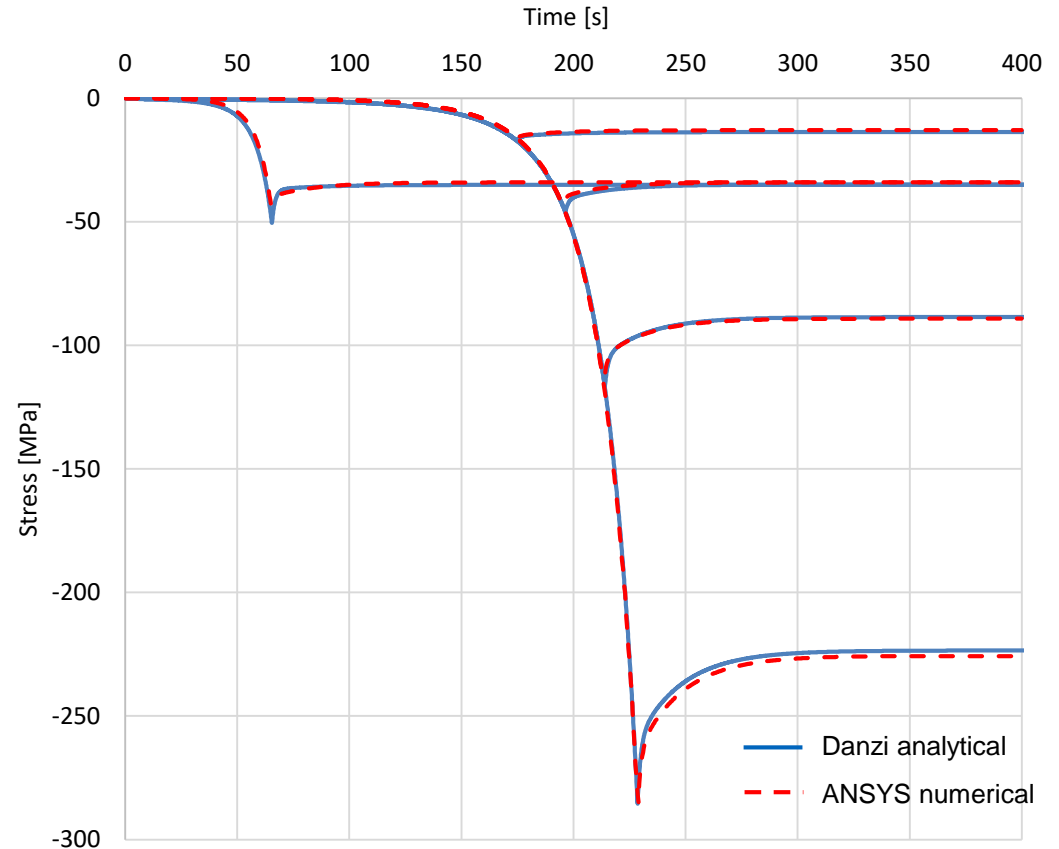

Comparison of numerical results (ANSYS) with experimental data from literature [2]

4. User defined material model

Implementation 1D Model

- Implementation of Danzi's model in a Fortran code
- Translation in an incremental formulation

Enhancement of the model

- No need to predefine relaxation time
- Non-constant compaction speed possible
- Reduction to 11 constants

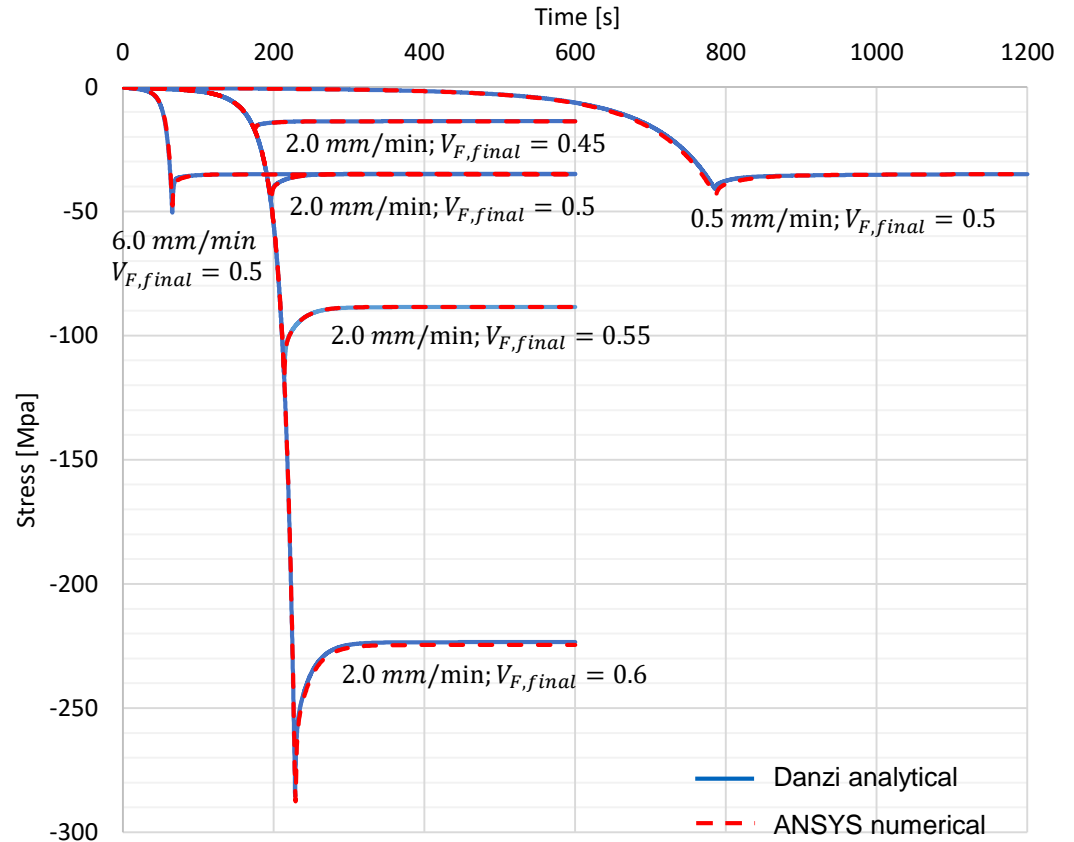

Numerical results of the enhanced model vs. analytical results from Danzi [5]

4. User defined material model

Application for NCF material

- Validation with compaction data from previous measurements [6]
- Biaxial carbon fiber NCF

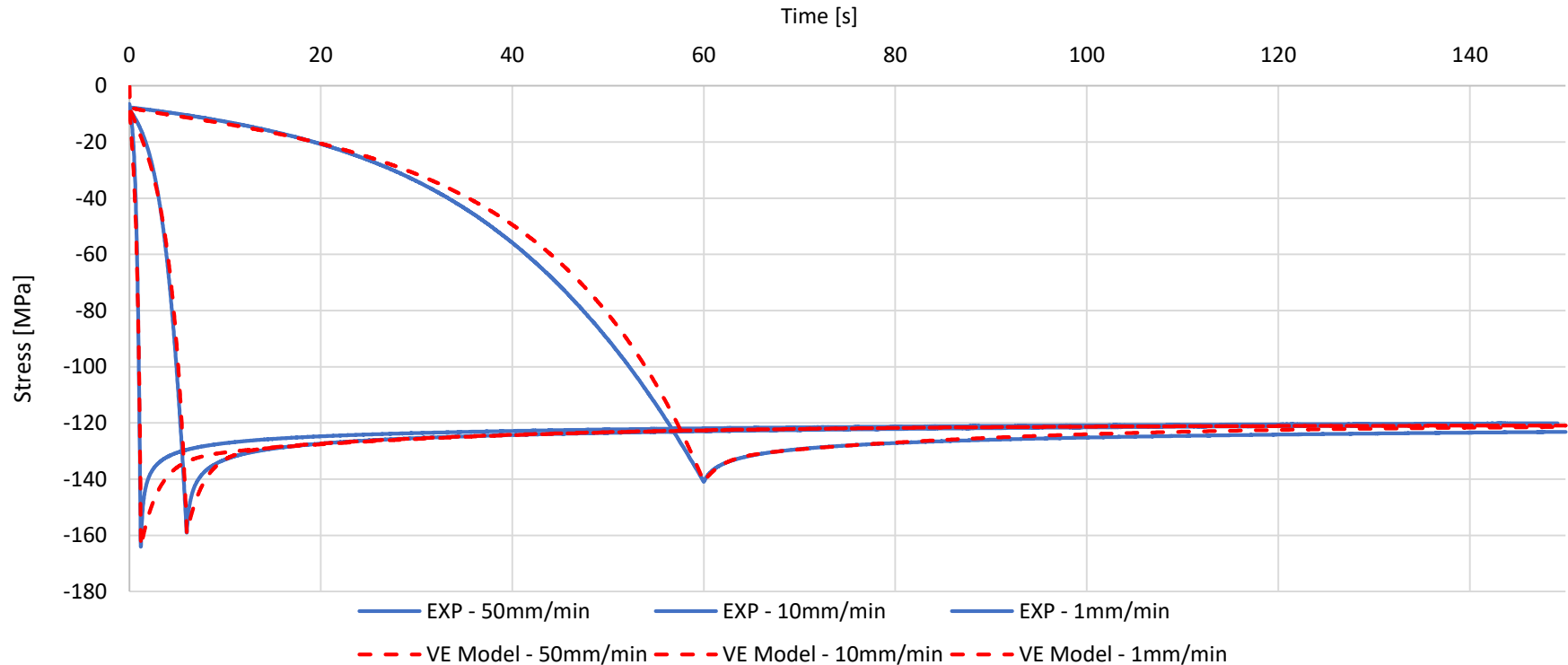

Experimental vs. analytical compaction stress of the enhanced model for biaxial carbon fiber preforms

4. User defined material model

Extension to a 3D Model

- Behavior defined by 9 independent constants

$$\begin{Bmatrix} \varepsilon_1 \\ \varepsilon_2 \\ \varepsilon_3 \\ \gamma_{23} \\ \gamma_{31} \\ \gamma_{12} \end{Bmatrix} = \begin{bmatrix} S_{11} & S_{12} & S_{13} & 0 & 0 & 0 \\ S_{12} & S_{22} & S_{23} & 0 & 0 & 0 \\ S_{13} & S_{23} & S_{33} & 0 & 0 & 0 \\ 0 & 0 & 0 & S_{44} & 0 & 0 \\ 0 & 0 & 0 & 0 & S_{55} & 0 \\ 0 & 0 & 0 & 0 & 0 & S_{66} \end{bmatrix} \cdot \begin{Bmatrix} \sigma_1 \\ \sigma_2 \\ \sigma_3 \\ \tau_{23} \\ \tau_{31} \\ \tau_{12} \end{Bmatrix}$$

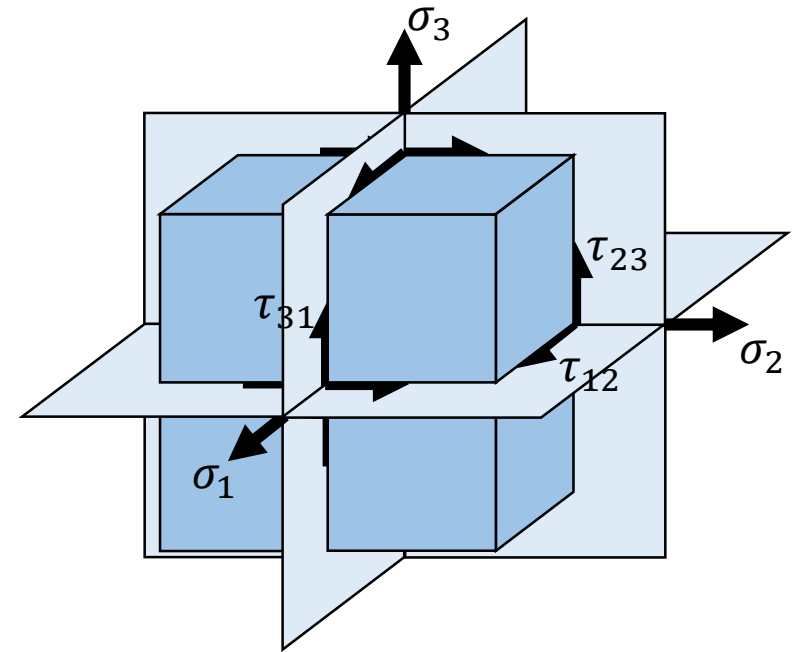

Material symmetry planes for an orthotropic material

- In plane stiffness E_1 and E_2
- In plane poisson's ratio ν_{12}
- Viscoelastic model for compaction
- Out of plane poisson's ratio ν_{23} and ν_{31}
- In plane shear stiffness G_{12}
- Out of plane shear stiffness G_{23} and G_{31}

4. User defined material model

Extension to a 3D Model

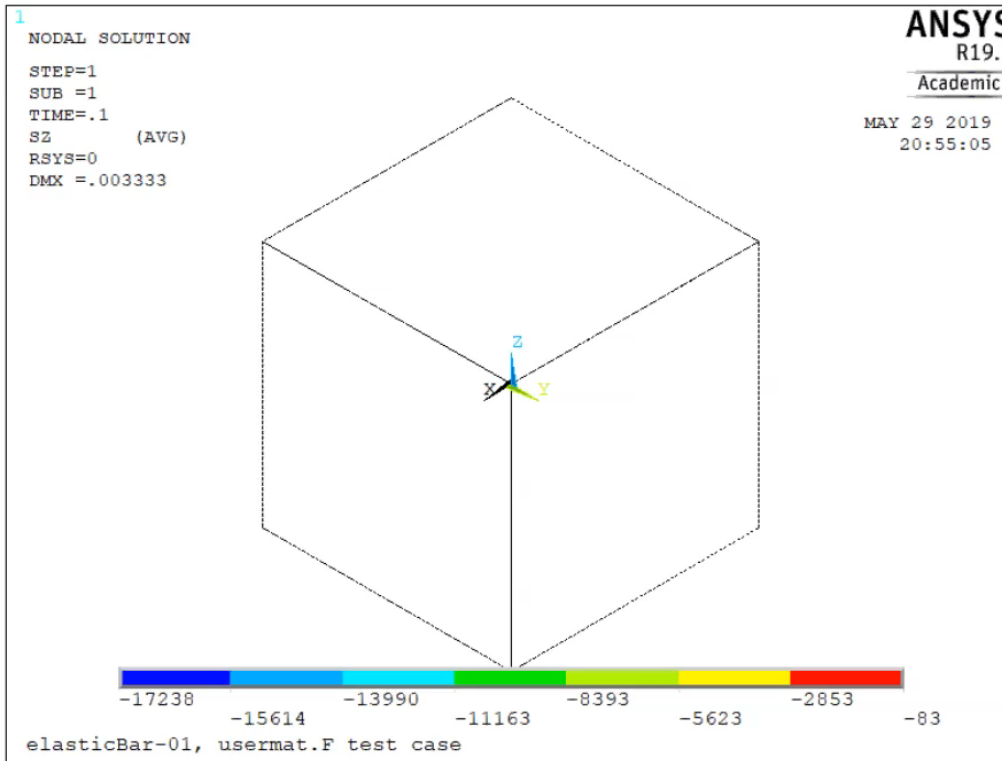

Animation: Stress in compaction direction

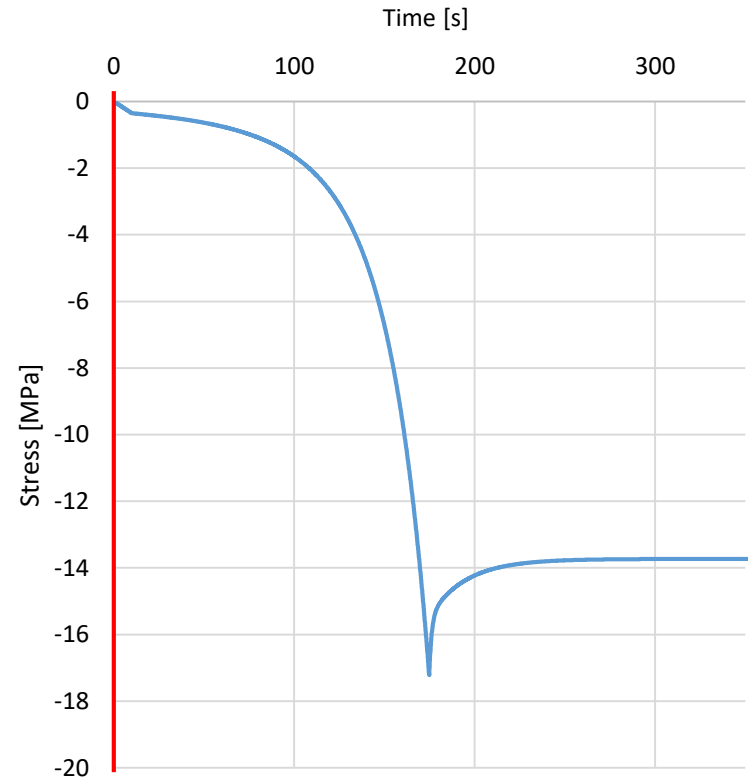

Compaction stress over time with compaction speed 2mm/min, FVF 0.45

5. Conclusion and Outlook

Conclusions

- Implementation with standard materials not possible in ANSYS
- Implementation of a user defined material in 1D
- Enhancement of the literature model
- Validation with two different materials

Outlook

- Materials characterization
- Fully implementation in 3D
- Validation with complex geometry

The authors would like to thank the European Union's Horizon2020 research program (ProTHiC project – project ID 821019) for funding this study.



6. References

- [1] Kim YR, McCarthy SP, Fanucci JP. Compressibility and relaxation of fiber reinforcements during composite processing. *Polym. Compos.* 1991;12(1):13–9.
- [2] Kelly PA, Umer R, Bickerton S (eds.). *Compaction of Dry and Wet Fibrous Materials during Infusion Processes*; 2004.
- [3] Kelly PA. A viscoelastic model for the compaction of fibrous materials. *Journal of the Textile Institute* 2011;102(8):689–99.
- [4] Somashekar AA, Bickerton S, Bhattacharyya D. Modelling the viscoelastic stress relaxation of glass fibre reinforcements under constant compaction strain during composites manufacturing. *Composites Part A: Applied Science and Manufacturing* 2012;43(7):1044–52.
- [5] Danzi M, Schneeberger C, Ermanni P. A model for the time-dependent compaction response of woven fiber textiles. *Composites Part A: Applied Science and Manufacturing* 2018;105:180–8.
- [6] Tagscherer N. *Material Characterization for a Numerical Compression Resin Transfer Molding Simulation*. Master's Thesis. Chair of Carbon Composites. Technical University of Munich. Munich; 2018

Questions?